



REF.

FA 60 016 02



EN 795:2012 Type B



22 kN / 60 mm

MAT.



+

FA 60 016 05



0.49 KG



MAT.

+

Résistance à la rupture / Ouverture
 Breaking strength / Gate opening
Resistencia a la ruptura / Apertura
 Resistenza alla rottura / Apertura
Bruchfestigkeit / Öffnung

Matière
 Material
Material
 Materia
Material

À utiliser avec
 To be used with
Para usar con
 Ad essere utilizzato con
Verwendet werden
 soll mit

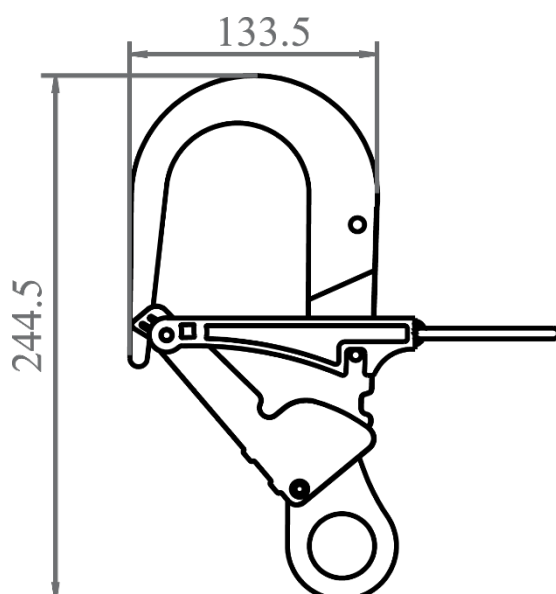

HS CODE

76161000

CARTON SIZE / PCS.

40x30x20 cm / 10

AET (EU) N°2777/10746-01/E01-01

Satra Technology Europe Ltd., N° 2777,
 Bracetown Business Park, Clonee,
 Dublin, D15YN2P, Ireland

MODULE D FI14/14003.02

SGS Fimko Oy, N°0598
 Takomotie 8,
 00380 HELSINKI, Finland